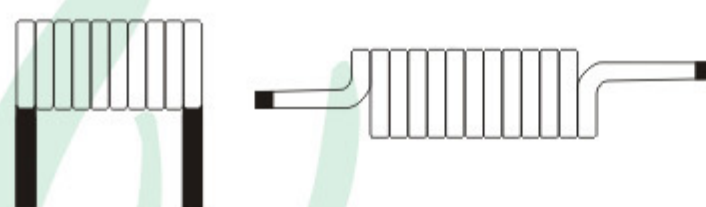
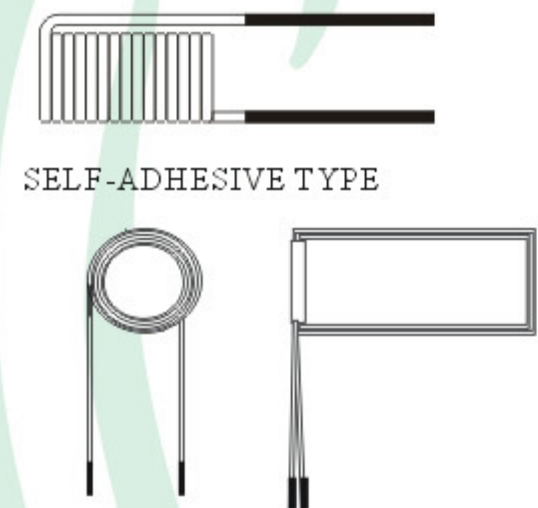
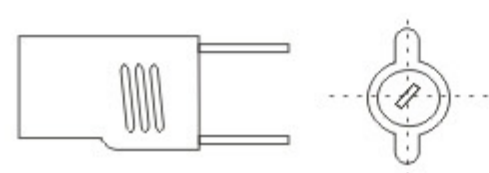
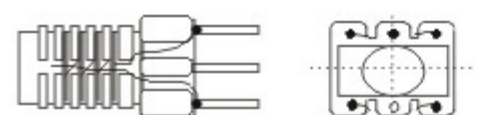
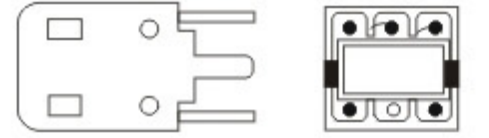

空芯綫圈

Spring coils

中頻變壓器

Intermediate Frequency Transformer

<p>SPRING TYPE</p>  <p>SELF-ADHESIVE TYPE</p> 	<p>Specification</p> <ul style="list-style-type: none"> ■ Copper wire range(可繞線徑): 0.2~3mm ■ Winding inner dimension(可繞內徑): 0.8~25mm ■ Rated current(可工作電流): ~40A ■ Working temperature(可工作溫度): ~250°C <ul style="list-style-type: none"> ■ Copper wire range(可繞線徑): 0.05~0.8mm ■ Winding inner dimension(可繞內徑): 1~700mm ■ Rated current(可工作電流): ~5A ■ Working temperature(可工作溫度): ~85°C ■ Winding shapes(可繞形狀): circle, square, ellipse, Triangle and other anomalous shapes (圓形, 方形, 橢圓形, 三角形等不規則形狀) 	<p>MD TYPE(塑模類)</p> 	<p>Model 5x5 6x6 7x7 9x9 10x10</p>	<p>Specification</p> <ul style="list-style-type: none"> ■ Inductance range(電感範圍): 0.01uH~0.6uH ■ Working frequency(可工作頻率): ~1000MHz ■ Q range : 50~180
		<p>RF TYPE(射頻類)</p> 		<ul style="list-style-type: none"> ■ Inductance range(電感範圍): 0.01uH~30uH ■ Working frequency(可工作頻率): ~300MHz ■ Q range : 40~180
		<p>OSCTYPE(偏磁振盪類)</p> 		<ul style="list-style-type: none"> ■ Inductance range(電感範圍): 0.01uH~3000uH ■ Working frequency(可工作頻率): ~200MHz ■ Q range : 40~180 ■ Int.cap on option range(匹配電容): 5PF~1500PF

典型應用回路(例):
TYPICAL APPLICATION CIRCUIT(EXAMPLES):

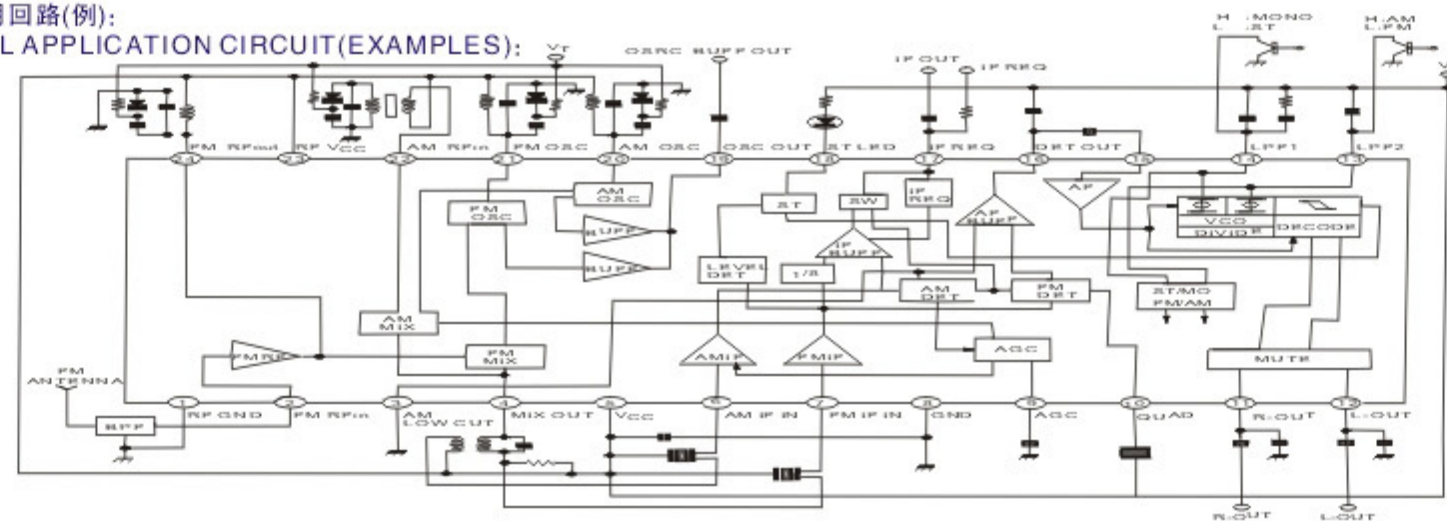
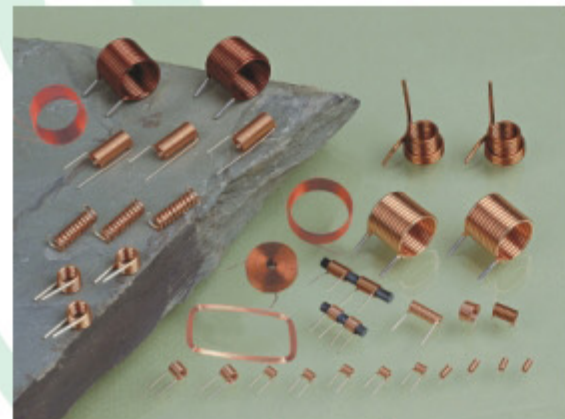

中英文說明	Specific Property 特性	Application 用途
	High frequency, High Self-Resonant frequency, High rated current 高頻率, 高共振頻率, 耐大電流	Microwave equipment, Television, Satellite mass, Communications system, Electronic toy, sound car. 微波設備, 電視, 衛星大眾傳播系統, 電子玩具, 車載音響等。

中英文說明	Specific Property 特性	Application 用途
	Variable inductance range. 電感可調。	CD, TV and Communication equipment, Frequency filter, noise filter. CD機, 電視及通訊設備, 電源控制及其它雜波, 濾波。

歡迎客戶提供規格 CUSTOMER SPECIFICATION IS WELCOME

歡迎客戶提供規格 CUSTOMER SPECIFICATION IS WELCOME